

Dicroica LED 230V 7W 600lm 3000K Base GU10

Codice **929916**

Modello **AP07DC**



Caratteristiche generali

- Base: GU10.
- Dimensioni: Ø50X55mm.
- Luce istantanea.
- Bassa temperatura.
- 0% Mercurio.

Caratteristiche illuminotecniche

- Flusso luminoso (Φ_{360°): 600lm.
- Temperatura di colore: 3000K.
- Angolo: 105°.
- CRI: 80.
- Durata: 25000 ore.
- Cicli di accensione: 12500.

Caratteristiche elettriche

- Tensione: 175-250V AC 50Hz.
- Potenza: 7W.
- Fattore di sfasamento: 0.5.
- Consumo: 7kWh/1000h.

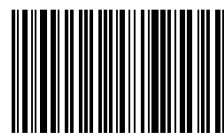
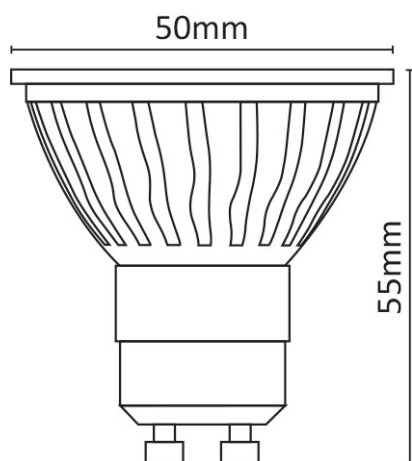

8055323219044